

Hacousto Holland bv
Industrieweg 87
2651BC Berkel & Rodenrijs



Impact Controller – Expander User and installation manual

Author:

DD



SUMMARY

This document describes the Controller-Expander, which is an optional network port expander dedicated to 4EVAC Voice Evacuation systems.

REVISION AND APPROVAL

Rev.	Date	Nature of Changes	Approved By
01	09-03-2020	Preliminary draft	DD
02	08-06-2020	Updated pictures, minor corrections	DD
03	11-06-2020	Corrections	TvdH
04	05-08-2021	Technical specifications corrections	AJH



Hacousto Holland bv Industrieweg 87 2651BC Berkel & Rodenrijs		
Impact Controller – Expander User and installation manual	Author:	DD

Table of Contents

1. What is the Controller-Expander?	3
2. Front panel.....	4
2.1. POWER	4
2.2. EVAC.....	4
2.3. GENERAL FAULT	4
2.4. POWER SUPPLY FAULT	4
2.5. SYSTEM FAULT	5
2.6. NETWORK FAULT	5
3. Rear panel	5
3.1. Local network	6
3.2. Global network.....	6
3.3. Device ID.....	6
3.4. Micro SD card.....	7
3.5. RESET button	7
4. Configuration settings.....	7
5. Network cabling	7
6. Connections and recommended cable types	8
7. Technical specifications.....	9

Hacousto Holland bv Industrieweg 87 2651BC Berkel & Rodenrijs		
Impact Controller – Expander User and installation manual	Author:	DD

1. What is the Controller-Expander?

4EVAC Controller-Expander is an optional component of the 19" rack mounted Impact Voice Evacuation System. The Controller-Expander is identical to the Impact Controller with significant hardware and functional limitations.



The Controller Expander cannot not be used alone as a standalone VACIE (Voice alarm control and indicating equipment), as it does not feature EN54-16 mandatory inputs / outputs. The Expander may be used in the system only as an additional interface, connected to the main network of 4EVAC VACIE main units.

Functionally, the 4EVAC Controller-Expander works as a network hub for additional L-Net devices, such as microphone stations.

In terms of interfacing, the Controller-Expander only features a DC power input and network ports (Global Network and Local Network).

The Controller-Expander includes:

- Front panel indicators
- DC power input
- Network ports:
 - o 2 x Global Network port – to interconnect multiple Controllers in a redundant ring topology
 - o 3 x Local Network port - for max. 16 local peripheral devices (e.g. mic consoles)
- microSD card with configuration settings
- 2 x hexadecimal rotary encoder (device ID setting)
- USB port for firmware upgrades
- RESET button – hard CPU reset

Hacousto Holland bv Industrieweg 87 2651BC Berkel & Rodenrijs		
Impact Controller – Expander User and installation manual	Author:	DD

2. Front panel



Indicators (functions identically to the Impact Controller, except power supply fault):

2.1. POWER

Indicates if the Controller is being powered and if the system is booted properly.

OFF	Not powered
GREEN continuous	This device is powered and operational.
GREEN blinking	This device is booting after power up / reset.

2.2. EVAC

Indicates that the system is in Voice Alarm, where at least one zone in the system is occupied by an emergency audio signal, i.e. a pre-recorded EVAC MESSAGE or LIVE EVAC, when a fireman mic is being used.

OFF	EVAC status is inactive (quiescent mode)
RED continuous	EVAC status is active

2.3. GENERAL FAULT

Indicates that the system is in FAULT condition (general fault indicator), where at least one device in the system is reporting a fault.

OFF	System is healthy
YELLOW continuous	Local fault is detected (this Controller-Expander)
YELLOW blinking	Local device (this Controller-Expander) is healthy and at least one remote device is reporting fault state

2.4. POWER SUPPLY FAULT

Not used.

The Controller-Expander (in comparison to the Impact Controller) has no management interface to power supply equipment, so there are no local power supply faults to be reported.

2.5. SYSTEM FAULT

Indicates a system fault of the Controller-Expander, where:

- A CPU or program execution is stopped or malfunctioning,
- Storage memory containing config settings and audio files (SD card) is corrupted.

Where the system fault is caused by a CPU or memory fault, the device remains in its “safe state” where critical functions (including audio transmission, reaction on control inputs, etc.) are stopped until the fault is resolved.

OFF	Firmware and settings OK
YELLOW continuous	CPU / program fault
YELLOW blinking	<ul style="list-style-type: none"> o SD card fault o Config file not compatible o Wrong ID setting

2.6. NETWORK FAULT

Indicates when any device or link in the network is missing.

OFF	Network OK
YELLOW continuous	At least one device from the Local Network of this Controller-Expander is missing.
YELLOW blinking slow	Global ring is broken (any place in the ring)

3. Rear panel

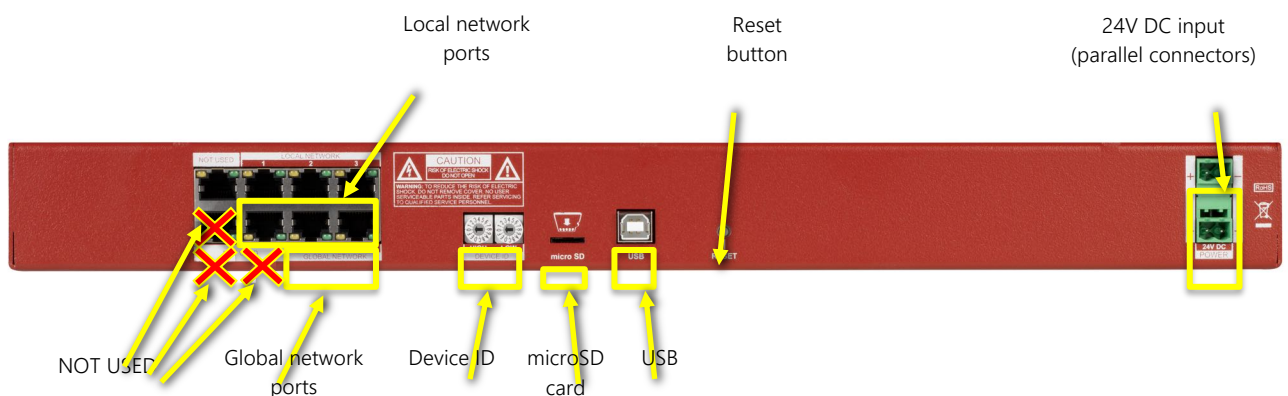

3.1. Local network

The L-Net daisy-chain topology is dedicated to peripheral devices of Controller, such as remote microphone stations. The L-Net is used to expand functionality of the Impact system to remote locations.

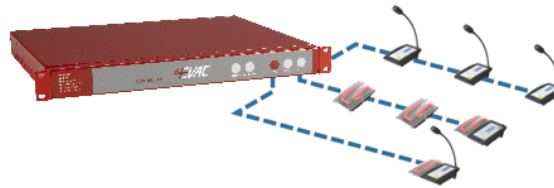

Multiple microphone stations may be used in the same L-Net, with the following limitations:

- ❖ A maximum of 8 stations per L-Net port
- ❖ A maximum of 16 stations per single 4EVAC main unit (total sum of all 3 L-net ports)

A microphone station may be also daisy-chained together with other L-Net devices

i NOTE: Controller expander does not support 4E-SW6.

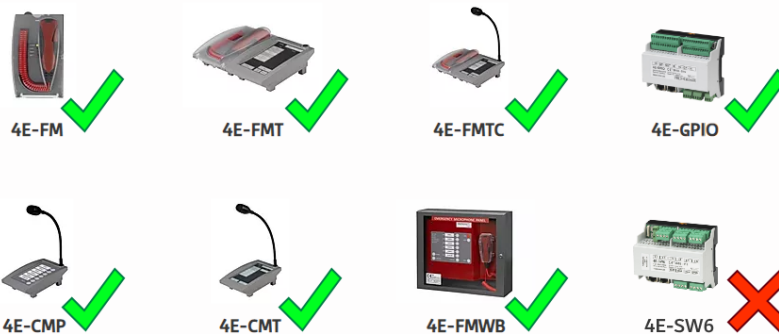

3.2. Global network

G-Net is a redundant network ring where multiple Controllers and Expanders may be connected into one system. It is used to reliably synchronize data between all connected devices and for multi-channel live audio transmission with very low latency. G-Net works as a redundant double ring between Controllers, which keeps the global system intact in case of single link failure.

i NOTE: The Controller expander must be connected with the main system unit (Impact Controller / Compact 500) via a redundant G-Net ring..

3.3. Device ID

The Controller-Expander is equipped with rotary switch that determines the Device ID (or device address) in the network. Make sure that the Device ID set on the rotary switch complies with the ID defined in configuration settings for this device.

The wrong ID setting will trigger a system fault because of a configuration error.

Hacousto Holland bv Industrieweg 87 2651BC Berkel & Rodenrijs		
Impact Controller – Expander User and installation manual	Author:	DD

3.4. Micro SD card

The Controller-Expander is supplied with a pre-installed micro SD memory card. The memory card contains the complete system configuration file.

The configuration file is prepared in the 4EVAC Manager – a Windows GUI application. More information about creating configuration settings can be found in the 4EVAC Manager User Manual.

The memory card is under constant surveillance, as well as its contents. When the memory card is removed, damaged or its contents are corrupted, the Controller will report a system fault. During the system fault caused by a memory error, the Controller enters a safe state where the system stops all functions and requires a reboot. This state can be reset only by a manual device reset.

3.5. RESET button

Press it to trigger a hard reset of the Expander (different from RESET button on front panel – soft reset)

4. Configuration settings

The Controller-Expander remains a G-Net device and as such can be supplemented with max. 16 L-Net devices, which will be local slaves of this Controller-Expander.

The Controller-Expander (in comparison to Impact Controller) requires no local configuration settings, except an ID / name / priority.



In the 4EVAC Manager configuration software, it is not possible to add a Controller-Expander without having at least one G-Net device in the configuration first, i.e.:

- Impact Controller
- Compact 500.

5. Network cabling

The 4EVAC network features a full duplex RS-422 data link and 24V DC power to remote devices.

If you're building a distributed system using the 4EVAC network, you should make physical links between devices using the right cables. Cabling should meet the following requirements:

1. Crossover twisted-pair cable (compatible with Ethernet crossover)

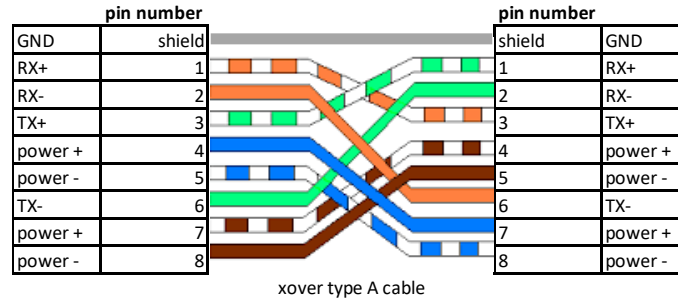

xover type A cable

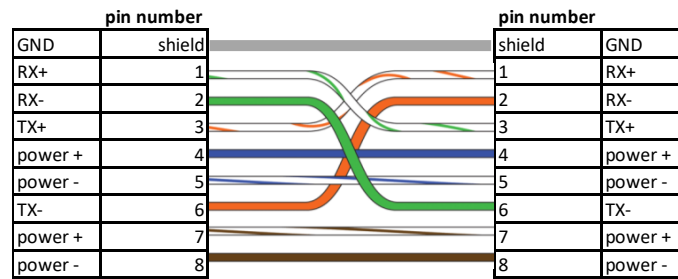

xover type B cable

2. CAT5e or higher for maximum distance of 250m.
3. Non-CAT / lower than CAT5e: 250m not guaranteed.
4. Shield required (at least FTP)



NOTE: If you use a straight cable, the device will power up but the Tx/Rx data terminals will not be properly connected. This will result in a communication fault between the L-Net device and main controller unit. The L-Net device will not be able to initialize, thus will remain in boot-sequence, not operational.



Caution! Use only crossover cables and keep the correct pinout! Connecting power pins to data pins will damage the network port.

6. Connections and recommended cable types

	How many	Connector type	Signal type	Additional information	Recommended cable (minimum)	Max. length
G-Net port	2	RJ-45	Full duplex RS-422	Redundant ring with power delivery	FTP CAT5e crossover	250m (to next device)
L-Net port	3			Daisy chain with power delivery		
DC Power in	1	Pluggable screw terminal block 5.08mm	24~30V DC	n/a	2 x 1.5mm ²	10m

Hacousto Holland bv Industrieweg 87 2651BC Berkel & Rodenrijs		
Impact Controller – Expander User and installation manual	Author:	DD

7. Technical specifications

Controller-Expander	
Controls and indications	
General indications	Power, evac, general fault LED indicators
Fault indications	System fault, network fault
	PSE integrated within DCA2.500, EN 54-4 certified.
DC input	24 – 30V DC
Power consumption	110 mA @24V DC
Audio	
Frequency response	
Network streaming	100 Hz – 12 kHz
Network audio stream format	24 kHz sampling, ADPCM compressed
Mechanical	
Dimensions (HxWxD)	4.4 x 44 x 34 cm (1U)
Housing material	Steel
IP rating	IP 30
Weight	4 kg
Mounting	19" rack mounting
Operating conditions	
Temperature (Ambient)	-5 ~ 40°C
Max. Temperature (Device)	65°C
Relative humidity	max. 90% (non condensing)
Storage temperature	-40 ~ 70°C
Network system	
Max. number of devices in the network	254
Number of simultaneous network audio channels	2
Network audio transmission latency	0.3 ms per device
Local network	
Architecture	Master-slave, up to 16 slave devices per Controller
Connection	3 x L-Net port, RJ-45, powered daisy chain, digital audio & control data
Cabling	X-over FTP CAT5e (or higher)
Current consumption	max. 500 mA per L-Net port,
Max. length of local bus	
default	250 m
with twisted-pair extender	500 m
Global network	
Architecture	Peer-to-peer, up to 255 Controllers
Connection	2 x G-Net port, RJ-45, powered redundant ring, digital audio & control data
Cabling	X-over FTP CAT5e (or higher) / multimode optical fiber
Current consumption	max. 500 mA per port, reserved only for network extenders
Max. distance between devices	
default	250 m
with twisted-pair extender	500 m
with fiber extenders	2500 m

All information provided in this document is subject to change without notice. 4EVAC may also make improvements and/or changes in the products described in this information at any time without notice.

Hacousto Holland bv Industrieweg 87 2651BC Berkel & Rodenrijs		
Impact Controller – Expander User and installation manual	Author:	DD



M A D E I N T H E N E T H E R L A N D S

4EVAC is a trade name of:

Hacousto Holland bv
 Industrieweg 87
 2651BC Berkel & Rodenrijs
 The Netherlands
www.4EVAC.com